



Figure can vary

Part no.: 50133642
PRK3C.BA3/4P-200-M12
Polarized retro-reflective photoelectric sensor



Contents

- Technical data
- Reflectors & reflective tapes
- Dimensioned drawings
- Electrical connection
- Diagrams
- Operation and display
- Part number code
- Accessories
- Notes

Technical data

| Basic data | |
|-------------------------------------|---|
| Series | 3C |
| Operating principle | Reflection principle |
| Special design | |
| Special design | Autocollimation |
| Optical data | |
| Operating range | Guaranteed operating range |
| Operating range | 0 ... 4 m, With reflector TK(S) 100x100 |
| Operating range limit | Typical operating range |
| Operating range limit | 0 ... 5 m, With reflector TK(S) 100x100 |
| Light source | LED, Red |
| LED light wavelength | 635 nm |
| Transmitted-signal shape | Pulsed |
| LED protection class | Exempt group (in acc. with EN 62471) |
| Electrical data | |
| Protective circuit | Polarity reversal protection Short circuit protected |
| Performance data | |
| Supply voltage | 10 ... 30 V, DC, Incl. residual ripple |
| Residual ripple | 0 ... 15 %, From U_B |
| Open-circuit current | 0 ... 15 mA |
| Outputs | |
| Number of digital switching outputs | 2 Piece(s) |
| Switching outputs | |
| Voltage type | DC |
| Switching current, max. | 100 mA |
| Switching voltage | Low: $\leq 2V$ High: $\geq (U_B - 2V)$ |
| Switching output 1 | |
| Assignment | Connection 1, pin 4 |
| Switching element | Transistor, PNP |
| Switching principle | Light switching |
| Switching output 2 | |
| Assignment | Connection 1, pin 2 |
| Switching element | Transistor, PNP |
| Switching principle | Dark switching |
| Timing | |
| Switching frequency | 1,500 Hz |
| Response time | 0.33 ms |
| Readiness delay | 300 ms |
| Response jitter | 110 μ s |
| Connection | |

Part no.: 50133642 – PRK3C.BA3/4P-200-M12 – Polarized retro-reflective

Connection 1

| | |
|--------------------|------------------------------|
| Type of connection | Cable with connector |
| Function | Voltage supply Signal OUT |
| Cable length | 200 mm |
| Sheathing material | PUR |
| Cable color | Black |
| Wire cross section | 0.2 mm ² |
| Thread size | M12 |
| Type | Male |
| Material | Metal |
| No. of pins | 4 -pin |
| Encoding | A-coded |

Mechanical data

| | |
|----------------------------|---|
| Dimension (W x H x L) | 11.4 mm x 34.2 mm x 18.3 mm |
| Housing material | Plastic, PC-ABS |
| Lens cover material | Plastic / PMMA |
| Net weight | 20 g |
| Housing color | Red |
| Type of fastening | Two M3 threaded sleeves Via optional mounting device |
| Compatibility of materials | ECOLAB |

Operation and display

| | |
|-------------------------------------|------------------------|
| Type of display | LED |
| Number of LEDs | 2 Piece(s) |
| Operational controls | Teach button |
| Function of the operational control | Sensitivity adjustment |

Environmental data

| | |
|--------------------------------|---------------|
| Ambient temperature, operation | -40 ... 60 °C |
| Ambient temperature, storage | -40 ... 70 °C |





Certifications

| | |
|----------------------|-----------------|
| Degree of protection | IP 69K IP 67 |
| Protection class | III |
| Certifications | c UL US |
| Standards applied | IEC 60947-5-2 |

Classification

| | |
|------------|----------|
| eCl@ss 8.0 | 27270902 |
| eCl@ss 9.0 | 27270902 |
| ETIM 5.0 | EC002717 |

Reflectors & reflective tapes

| | Part no. | Designation | Operating range/ Operating range limit | Description |
|---|----------|---------------|---|--|
|  | 50108300 | REF 4-A-50x50 | 0 ... 0.7 m 0 ... 1 m | Design: Rectangular Reflective surface: 50 mm x 50 mm Material: Plastic Chemical designation of the material: PMMA Fastening: Self-adhesive |
|  | 50003192 | TK 100x100 | 0 ... 4 m 0 ... 5 m | Design: Rectangular Reflective surface: 96 mm x 96 mm Triple reflector size: 4 mm Material: Plastic Base material: Plastic Chemical designation of the material: PMMA8N Fastening: Adhesive |
|  | 50022816 | TKS 100X100 | 0 ... 4 m 0 ... 5 m | Design: Rectangular Reflective surface: 96 mm x 96 mm Triple reflector size: 4 mm Material: Plastic Base material: Plastic Chemical designation of the material: PMMA8N Fastening: Through-hole mounting, Adhesive |
|  | 50081283 | TKS 20X40 | 0 ... 1.3 m 0 ... 1.5 m | Design: Rectangular Reflective surface: 16 mm x 38 mm Triple reflector size: 2.3 mm Material: Plastic Base material: Plastic Chemical designation of the material: PMMA8N Fastening: Through-hole mounting, Adhesive |
|  | 50040820 | TKS 40X60 | 0 ... 2.6 m 0 ... 3.2 m | Design: Rectangular Reflective surface: 37 mm x 56 mm Triple reflector size: 4 mm Material: Plastic Base material: Plastic Chemical designation of the material: PMMA8N Fastening: Through-hole mounting, Adhesive |

Dimensioned drawings

All dimensions in millimeters

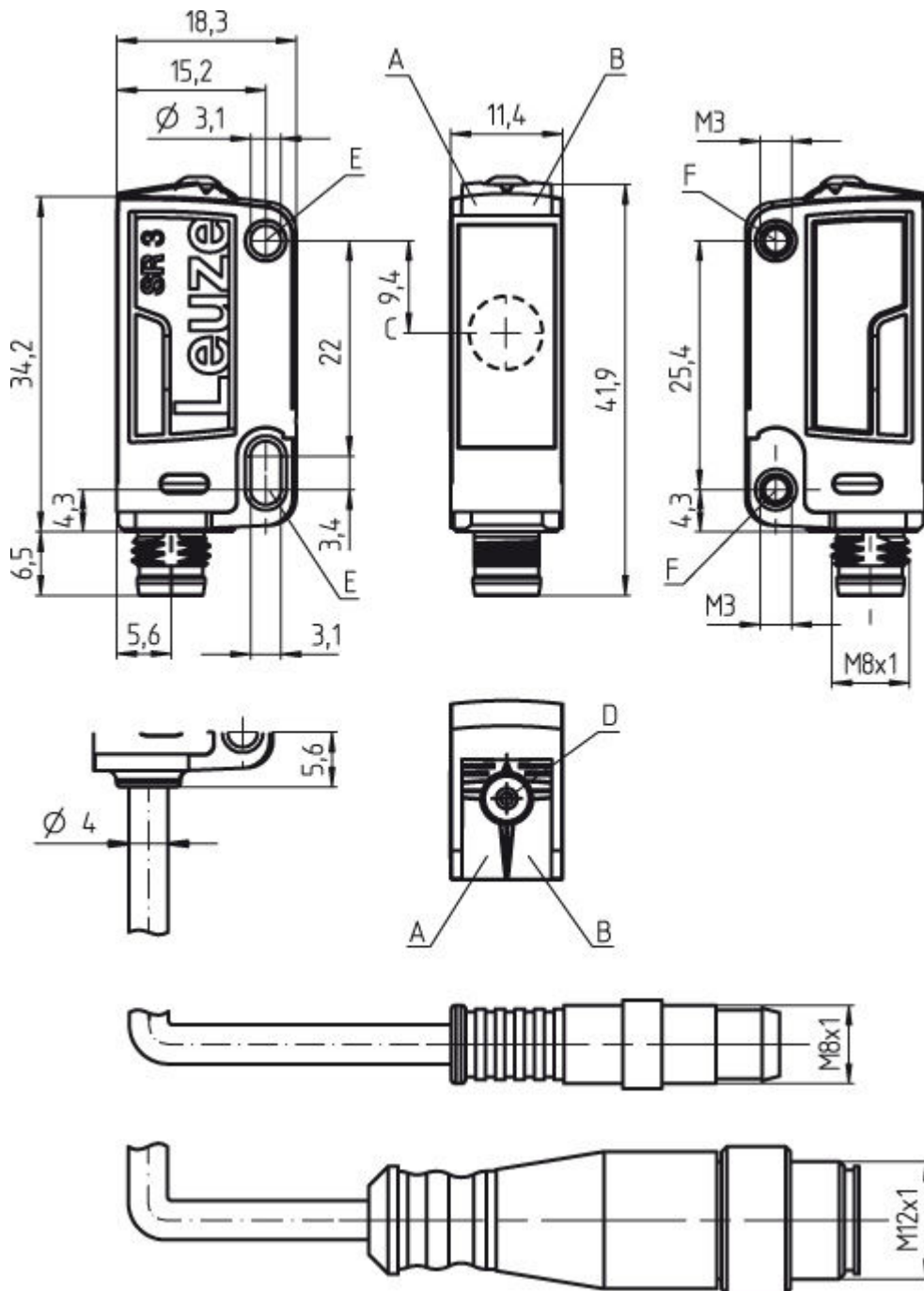

- A Green LED
- B Yellow LED
- C Optical axis
- D Teach button
- E Mounting sleeve (standard)
- F Threaded sleeve (3C.B series)

Electrical connection

| Connection 1 | |
|--------------------|------------------------------|
| Type of connection | Cable with connector |
| Function | Voltage supply Signal OUT |

| Connection 1 | |
|--------------------|---------------------|
| Cable length | 200 mm |
| Sheathing material | PUR |
| Cable color | Black |
| Wire cross section | 0.2 mm ² |
| Thread size | M12 |
| Type | Male |
| Material | Metal |
| No. of pins | 4 -pin |
| Encoding | A-coded |

| Pin | Pin assignment |
|-----|----------------|
| 1 | V+ |
| 2 | OUT 2 |
| 3 | GND |
| 4 | OUT 1 |

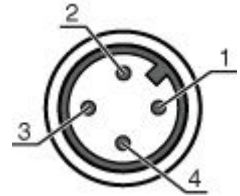

Diagrams

Typ. response behavior

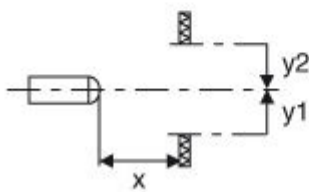
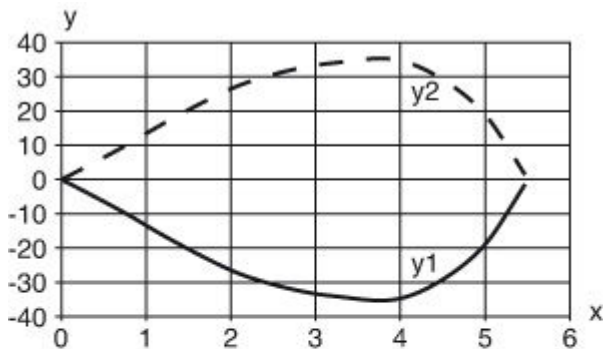

x Distance [m]
y Misalignment [mm]

Typ. function reserve

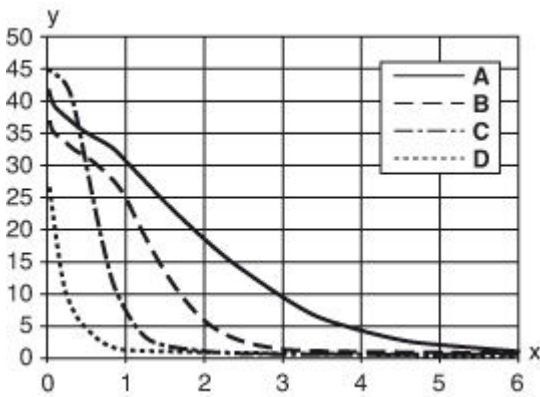

- x Distance [m]
- y Function reserve
- A TKS 100x100
- B TKS 40x60
- C TKS 20x40
- D Film REF 4-A-50x50

Operation and display

LEDs

| LED | Display | Meaning |
|-----|--------------------------|--------------------------------------|
| 1 | Green, continuous light | Ready |
| 2 | Yellow, continuous light | Light path free |
| | Yellow, flashing | Light path free, no function reserve |

Part number code



Part designation: **AAA 3C d EE-f.GG H/i J-K**

| | |
|-------|---|
| AAA3C | Operating principle / construction: HT3C: diffuse reflection sensor with background suppression LS3C: throughbeam photoelectric sensor transmitter LE3C: throughbeam photoelectric sensor receiver PRK3C: retro-reflective photoelectric sensor with polarization filter |
| d | Light type: n/a: red light l: infrared light |
| EE | Light source: n/a: LED L1: laser class 1 L2: laser class 2 |
| f | Pre-set range (optional): n/a: operating range acc. to data sheet XXXX: pre-set range [mm] |

| | |
|----|--|
| GG | Equipment: n/a: standard A: autocollimation principle (single lens) for positioning tasks B: housing model with two M3 threaded sleeves, brass F: permanently set range L: long light spot S: small light spot T: autocollimation principle (single lens) for highly transparent bottles without tracking TT: autocollimation principle (single lens) for highly transparent bottles with tracking V: V-optics XL: extra long light spot |
| H | Operating range adjustment: n/a with HT: range adjustable via 8-turn potentiometer n/a with retro-reflective photoelectric sensors (PRK): operating range not adjustable 1: 270° potentiometer 3: teach-in via button 6: auto-teach |
| i | Switching output/function OUT 1/IN: Pin 4 or black conductor: 2: NPN transistor output, light switching N: NPN transistor output, dark switching 4: PNP transistor output, light switching P: PNP transistor output, dark switching 6: push-pull switching output, PNP light switching, NPN dark switching G: push-pull switching output, PNP dark switching, NPN light switching L: IO-Link 8: activation input (activation with high signal) X: pin not used |
| J | Switching output / function OUT 2/IN: pin 2 or white conductor: 2: NPN transistor output, light switching N: NPN transistor output, dark switching 4: PNP transistor output, light switching P: PNP transistor output, dark switching 6: push-pull switching output, PNP light switching, NPN dark switching G: push-pull switching output, PNP dark switching, NPN light switching W: warning output X: not connected (n. c.) 8: activation input (activation with high signal) 9: deactivation input (deactivation with high signal) T: teach-in via cable |
| K | Electrical connection: n/a: cable, PVC, standard length 2000 mm, 4-wire 5000: cable, PVC, standard length 5000 mm, 4-wire M8: M8 connector, 4-pin (plug) M8.3: M8 connector, 3-pin (plug) 200-M8: cable, PVC, length 200 mm with M8 connector, 4-pin, axial (plug) 200-M8.3: cable, PVC, length 200 mm with M8 connector, 3-pin, axial (plug) 200-M12: cable, PVC, length 200 mm with M12 connector, 4-pin, axial (plug) |

Accessories



Connection technology - Connection cables

| | Part no. | Designation | Article | Description |
|---|----------|--------------------|------------------|--|
|  | 50104570 | K-D M12A-4P-2m-FAB | Connection cable | Connection 1: Connector, M12, Axial, Female, A-coded, 4 -pin Connection 2: Open end Shielded: No Cable length: 2,000 mm Sheathing material: FAB |
|  | 50104572 | K-D M12A-4P-5m-FAB | Connection cable | Connection 1: Connector, M12, Axial, Female, A-coded, 4 -pin Connection 2: Open end Shielded: No Cable length: 5,000 mm Sheathing material: FAB |
|  | 50104571 | K-D M12W-4P-2m-FAB | Connection cable | Connection 1: Connector, M12, Angled, Female, A-coded, 4 -pin Connection 2: Open end Shielded: No Cable length: 2,000 mm Sheathing material: FAB |





Part no.: 50133642 – PRK3C.BA3/4P-200-M12 – Polarized retro-reflective

| | Part no. | Designation | Article | Description |
|---|----------|---------------------------|------------------|---|
|  | 50104573 | K-D M12W-4P-5m- FAB | Connection cable | Connection 1: Connector, M12, Angled, Female, A-coded, 4 -pin Connection 2: Open end Shielded: No Cable length: 5,000 mm Sheathing material: FAB |
|  | 50130654 | KD U-M12-4A- P1-020 | Connection cable | Connection 1: Connector, M12, Axial, Female, A-coded, 4 -pin Connection 2: Open end Shielded: No Cable length: 2,000 mm Sheathing material: PUR |
|  | 50130657 | KD U-M12-4A- P1-050 | Connection cable | Connection 1: Connector, M12, Axial, Female, A-coded, 4 -pin Connection 2: Open end Shielded: No Cable length: 5,000 mm Sheathing material: PUR |
|  | 50130658 | KD U-M12-4A- P1-100 | Connection cable | Connection 1: Connector, M12, Axial, Female, A-coded, 4 -pin Connection 2: Open end Shielded: No Cable length: 10,000 mm Sheathing material: PUR |
|  | 50130648 | KD U-M12-4A- V1-020 | Connection cable | Connection 1: Connector, M12, Axial, Female, A-coded, 4 -pin Connection 2: Open end Shielded: No Cable length: 2,000 mm Sheathing material: PVC |
|  | 50130652 | KD U-M12-4A- V1-050 | Connection cable | Connection 1: Connector, M12, Axial, Female, A-coded, 4 -pin Connection 2: Open end Shielded: No Cable length: 5,000 mm Sheathing material: PVC |
|  | 50130653 | KD U-M12-4A- V1-100 | Connection cable | Connection 1: Connector, M12, Axial, Female, A-coded, 4 -pin Connection 2: Open end Shielded: No Cable length: 10,000 mm Sheathing material: PVC |
|  | 50130692 | KD U-M12-4W- P1-020 | Connection cable | Connection 1: Connector, M12, Angled, Female, A-coded, 4 -pin Connection 2: Open end Shielded: No Cable length: 2,000 mm Sheathing material: PUR |
|  | 50130694 | KD U-M12-4W- P1-050 | Connection cable | Connection 1: Connector, M12, Angled, Female, A-coded, 4 -pin Connection 2: Open end Shielded: No Cable length: 5,000 mm Sheathing material: PUR |
|  | 50130695 | KD U-M12-4W- P1-100 | Connection cable | Connection 1: Connector, M12, Angled, Female, A-coded, 4 -pin Connection 2: Open end Shielded: No Cable length: 10,000 mm Sheathing material: PUR |

Part no.: 50133642 – PRK3C.BA3/4P-200-M12 – Polarized retro-reflective

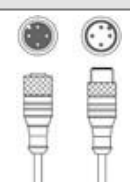
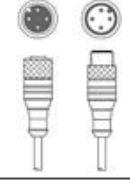
| | Part no. | Designation | Article | Description |
|---|----------|--------------------|------------------|---|
|  | 50130688 | KD U-M12-4W-V1-020 | Connection cable | Connection 1: Connector, M12, Angled, Female, A-coded, 4 -pin Connection 2: Open end Shielded: No Cable length: 2,000 mm Sheathing material: PVC |
|  | 50130690 | KD U-M12-4W-V1-050 | Connection cable | Connection 1: Connector, M12, Angled, Female, A-coded, 4 -pin Connection 2: Open end Shielded: No Cable length: 5,000 mm Sheathing material: PVC |
|  | 50130691 | KD U-M12-4W-V1-100 | Connection cable | Connection 1: Connector, M12, Angled, Female, A-coded, 4 -pin Connection 2: Open end Shielded: No Cable length: 10,000 mm Sheathing material: PVC |

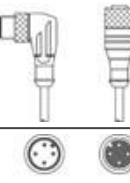



Connection technology - Interconnection cables

| | Part no. | Designation | Article | Description |
|---|----------|----------------------------|-----------------------|--|
|  | 50130741 | KDS U-M12-4A-M12-4A-P1-020 | Interconnection cable | Connection 1: Connector, M12, Axial, Female, A-coded, 4 -pin Connection 2: Connector, M12, Axial, Male, A-coded, 4 -pin Shielded: No Cable length: 2,000 mm Sheathing material: PUR |
|  | 50130743 | KDS U-M12-4A-M12-4A-P1-050 | Interconnection cable | Connection 1: Connector, M12, Axial, Female, A-coded, 4 -pin Connection 2: Connector, M12, Axial, Male, A-coded, 4 -pin Shielded: No Cable length: 5,000 mm Sheathing material: PUR |
|  | 50130744 | KDS U-M12-4A-M12-4A-P1-100 | Interconnection cable | Connection 1: Connector, M12, Axial, Female, A-coded, 4 -pin Connection 2: Connector, M12, Axial, Male, A-coded, 4 -pin Shielded: No Cable length: 10,000 mm Sheathing material: PUR |
|  | 50130759 | KDS U-M12-4A-M12-4W-P1-020 | Interconnection cable | Connection 1: Connector, M12, Axial, Female, A-coded, 4 -pin Connection 2: Connector, M12, Angled, Male, A-coded, 4 -pin Shielded: No Cable length: 2,000 mm Sheathing material: PUR |
|  | 50130761 | KDS U-M12-4A-M12-4W-P1-050 | Interconnection cable | Connection 1: Connector, M12, Axial, Female, A-coded, 4 -pin Connection 2: Connector, M12, Angled, Male, A-coded, 4 -pin Shielded: No Cable length: 5,000 mm Sheathing material: PUR |
|  | 50130753 | KDS U-M12-4A-M12-4W-V1-020 | Interconnection cable | Connection 1: Connector, M12, Axial, Female, A-coded, 4 -pin Connection 2: Connector, M12, Angled, Male, A-coded, 4 -pin Shielded: No Cable length: 2,000 mm Sheathing material: PVC |



Part no.: 50133642 – PRK3C.BA3/4P-200-M12 – Polarized retro-reflective

| | Part no. | Designation | Article | Description |
|---|----------|----------------------------|-----------------------|--|
|  | 50130755 | KDS U-M12-4A-M12-4W-V1-050 | Interconnection cable | Connection 1: Connector, M12, Axial, Female, A-coded, 4 -pin Connection 2: Connector, M12, Angled, Male, A-coded, 4 -pin Shielded: No Cable length: 5,000 mm Sheathing material: PVC |



Mounting technology - Mounting brackets

| | Part no. | Designation | Article | Description |
|---|----------|---------------|---------------------|---|
|  | 50118542 | BT 200M.5 | Mounting bracket | Design of mounting device: Angle, L-shape Fastening, at system: Through-hole mounting Mounting bracket, at device: Screw type Type of mounting device: Adjustable Material: Stainless steel |
|  | 50124651 | BT 205M-10SET | Mounting device set | Contains: 10x Design of mounting device: Angle, L-shape Fastening, at system: Through-hole mounting Mounting bracket, at device: Screw type Type of mounting device: Rigid Material: Metal |
|  | 50060511 | BT 3 | Mounting device | Design of mounting device: Angle, L-shape Fastening, at system: Through-hole mounting Mounting bracket, at device: Screw type Type of mounting device: Rigid Material: Metal |
|  | 50105585 | BT 3.1 | Mounting strap set | Contains: 10x Design of mounting device: Retaining clip Fastening, at system: Through-hole mounting Mounting bracket, at device: Screw type Type of mounting device: Rigid Material: Metal |
|  | 50105546 | BT 3B | Mounting device | Design of mounting device: Angle, L-shape Fastening, at system: Through-hole mounting Mounting bracket, at device: Screw type Type of mounting device: Rigid Material: Metal |





Mounting technology - Rod mounts

| | Part no. | Designation | Article | Description |
|---|----------|--------------|-----------------|---|
|  | 50117256 | BTU 200M-D10 | Mounting system | Contains: 2x M3 x 18 screw, 2x position washers Design of mounting device: Mounting system Fastening, at system: For 10 mm rod, Sheet-metal mounting Mounting bracket, at device: Screw type Type of mounting device: Clampable, Adjustable, Turning, 360° Material: Metal |
|  | 50117255 | BTU 200M-D12 | Mounting system | Contains: 2x M3 x 18 screw, 2x position washers Design of mounting device: Mounting system Fastening, at system: For 12 mm rod, Sheet-metal mounting Mounting bracket, at device: Screw type Type of mounting device: Clampable, Adjustable, Turning, 360° Material: Metal |

Part no.: 50133642 – PRK3C.BA3/4P-200-M12 – Polarized retro-reflective

| | Part no. | Designation | Article | Description |
|---|----------|----------------|-----------------|---|
|  | 50117254 | BTU 200M-D14 | Mounting system | Contains: 2x M3 x 18 screw, 2x position washers Design of mounting device: Mounting system Fastening, at system: For 14 mm rod, Sheet-metal mounting Mounting bracket, at device: Screw type Type of mounting device: Clampable, Adjustable, Turning, 360° Material: Metal |
|  | 50120426 | BTU 200M.5-D12 | Mounting system | Contains: 2x M3 x 18 screw, 2x M3 mounting nut, 2x position washers Design of mounting device: Mounting system Fastening, at system: For 12 mm rod Mounting bracket, at device: Screw type Type of mounting device: Turning, 360°, Clampable, Adjustable Material: Stainless steel |

Standard reflectors

| | Part no. | Designation | Article | Description |
|---|----------|--------------|-----------|--|
|  | 50134985 | MTKS 20x30.1 | Reflector | Design: Rectangular Reflective surface: 18.5 mm x 28.5 mm Triple reflector size: 1 mm Material: Plastic Base material: Plastic Chemical designation of the material: PMMA Fastening: Through-hole mounting, Adhesive |
|  | 50003192 | TK 100x100 | Reflector | Design: Rectangular Reflective surface: 96 mm x 96 mm Triple reflector size: 4 mm Material: Plastic Base material: Plastic Chemical designation of the material: PMMA8N Fastening: Adhesive |
|  | 50022816 | TKS 100X100 | Reflector | Design: Rectangular Reflective surface: 96 mm x 96 mm Triple reflector size: 4 mm Material: Plastic Base material: Plastic Chemical designation of the material: PMMA8N Fastening: Through-hole mounting, Adhesive |
|  | 50081283 | TKS 20X40 | Reflector | Design: Rectangular Reflective surface: 16 mm x 38 mm Triple reflector size: 2.3 mm Material: Plastic Base material: Plastic Chemical designation of the material: PMMA8N Fastening: Through-hole mounting, Adhesive |
|  | 50040820 | TKS 40X60 | Reflector | Design: Rectangular Reflective surface: 37 mm x 56 mm Triple reflector size: 4 mm Material: Plastic Base material: Plastic Chemical designation of the material: PMMA8N Fastening: Through-hole mounting, Adhesive |

Reflective tapes for standard applications

| | Part no. | Designation | Article | Description |
|---|----------|---------------|-----------------|---|
|  | 50108300 | REF 4-A-50x50 | Reflective tape | Design: Rectangular Reflective surface: 50 mm x 50 mm Material: Plastic Chemical designation of the material: PMMA Fastening: Self-adhesive |

Notes

Observe intended use!

- This product is not a safety sensor and is not intended as personnel protection.
- The product may only be put into operation by competent persons.
- Only use the product in accordance with its intended use.

For UL applications:

- For UL applications, use is only permitted in Class 2 circuits in accordance with the NEC (National Electric Code).
- These proximity switches shall be used with UL Listed Cable assemblies rated 30V, 0.5A min, in the field installation, or equivalent (categories: CYJV/CYJV7 or PVVA/PVVA7)

- Light source: Average life expectancy 100,000 h at an ambient temperature of 25 °C
- Response time: For short decay times, an ohmic load of approx. 5 kOhm is recommended
- Sum of the output currents for both outputs, 50 mA for ambient temperatures > 40 °C